

INSTALLATION INSTRUCTIONS MODEL 1200 DOG WATERER

NELSON[®]



READ OWNER'S MANUAL CAREFULLY BEFORE INSTALLING.

Nelson Model 1200 Automatic Waterer provides a constant supply of fresh water and eliminates the hassles and expense of manually watering. The Model 1200 is made from tough 304 stainless steel, is virtually maintenance-free and is designed for easy cleaning.

WARNING! Install waterer near floor drain when locating waterer in a building - homes, garages, etc. Locate waterer near a floor drain so that if waterer overflows, water will go down floor drain and not damage building. Failure to locate waterer near a floor drain could result in water damage to building if waterer overflow occurs.

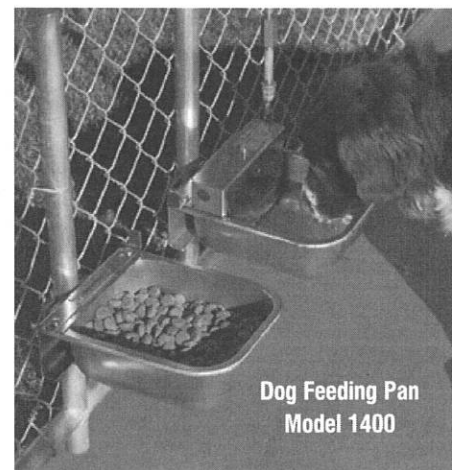
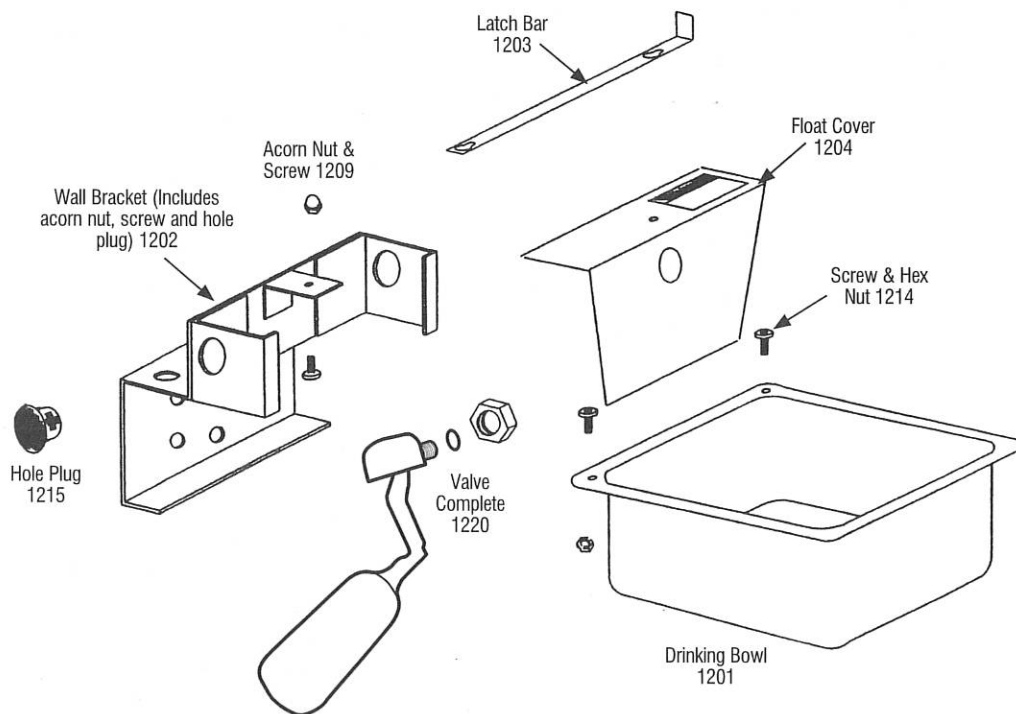

Dog Feeding Pan
Model 1400



Questions?
or to place an order:
Phone: 888-844-6606
www.nelsonmfg.com
Monday-Friday 7:30-5:00 CST



OPERATION

Water passes through float valve into the drinking bowl. As the bowl fills with water, the float rises until water is shut off due to action of the float arm. When the animal drinks, water is removed from the bowl lowering the float. This reduces the pressure of the valve seat on the valve orifice, allowing water to enter the bowl.



WATERLINE CONNECTION

Faucet Connection. Mounting the waterer next to an outdoor faucet is a popular installation. Nelson's garden hose adapter (Accessory K3) provides a fast and easy connection. The garden hose adapter consists of a one foot length of stainless steel braided garden hose with fittings on each end for easily connecting to an outdoor faucet. The faucet also serves as a handy shut-off valve to be used when cleaning the drinking bowl. To utilize a single faucet for multiple purposes consider obtaining an inexpensive 2-way faucet adapter available at most home improvement centers and hardware stores.

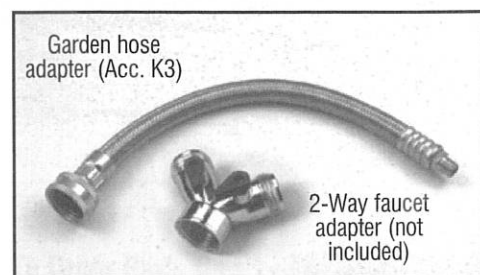

Pipe or Tubing Connection.

More permanent waterline materials may include iron pipe, copper pipe, brass pipe, copper tubing and plastic tubing. Connect waterline making certain to locate a pipe union or a compression connector in the line near the valve as it may be necessary to disconnect the water line to remove float valve for maintenance. It is recommended that a waterline shut off valve be installed in the waterline where it is handy to reach. Water can then be easily shut-off when cleaning or performing maintenance. Waterline can be brought to the waterer from above, below, behind or straight out, which ever is convenient. Use Teflon thread sealing tape on the Nelson Garden Hose Adaptor (Acc. K3) or your 1/8" male NPT fitting before connecting the waterline to valve.



ASSEMBLY

Step 1. Mount Wall Bracket on Wall or Kennel Pole

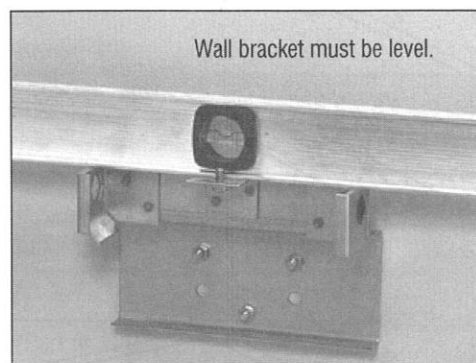

Mount on Wall - Three 5/16" diameter bolts are required for mounting wall bracket to wall. Two carriage bolts (1 1/2" long X 5/16" diameter) and nuts are included with the Nelson's pole mounting kit (Accessory K2). The carriage bolts may or may not work with the type and thickness of your wall. It may be that 5/16" lag bolts are desirable. Lag bolts can be obtained at a local hardware store. Locate waterer such that the top holes in the wall mounting bracket are a minimum of 9 inches above the floor. This allows enough room to remove the drinking bowl for cleaning.

Attach wall bracket to wall using two top holes and center bottom hole. The wall bracket must be level, requiring the use of a level when locating the holes on the wall. If the waterer is installed inside, locate it near a drain for cleaning convenience.

Mount on Kennel Pole - The pole mounting bracket kit (Accessory K2) contains the necessary bolts, nuts and brackets to mount the waterer to most kennel poles. Attach wall bracket to pole using top two holes. Locate waterer such that the top holes in the wall mounting bracket are a minimum of 9 inches above the floor. This allows enough room to remove the drinking bowl for cleaning. If the waterer is installed inside, locate it near a drain for cleaning convenience.

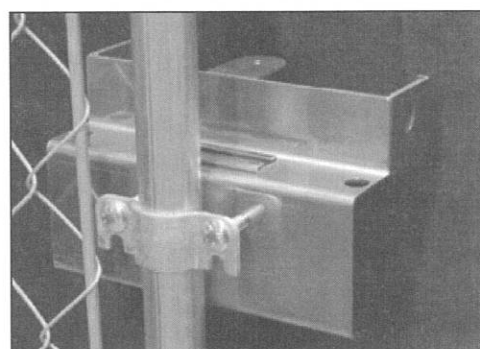

Pole Mounting Kit (Acc. K2)

Step 2. Attach Valve to Wall Bracket

1. Remove washer and valve nut located on valve.

2. Valve can be located on either right or left side of wall bracket. Place valve body through hole such that valve body fits in hex hole on bracket. Secure valve to wall bracket with the washer and nut removed earlier. Valve should be installed with float arm hanging directly downward. Push black hole plug in hole on opposite side of valve.

Step 3. Attach Drinking Bowl to Wall Bracket

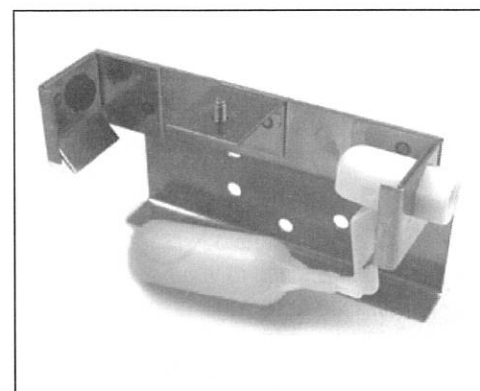

1. Mounting drinking bowl to wall bracket requires the hardware in the plastic pack (2 Phillips head screws, 2 hex nuts and 1 acorn nut).

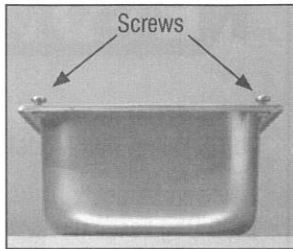

2. Thread both screws into holes in back two corners of drinking bowl.

Thread screws from the top with screw heads up. Tighten screws so that screw heads just make contact with surface of bowl then back out 2 3/4 complete rotations. The length the

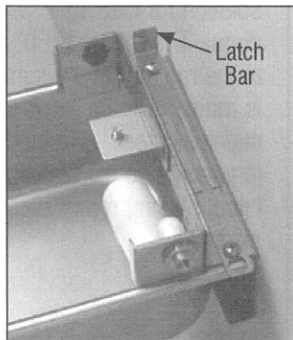

screws are backed out of drinking bowl determines how tight the latch bar operates. The latch bar locks and releases the drinking bowl from the wall bracket. The further the screws are backed out the looser the latch bar operates. Conversely, the further the screws are set into the drinking bowl the tighter the latch bar operates. Some experimentation may be required to find the optimal setting.

3. Once proper setting of screws is determined, lock the screws in place by installing a hex nut on bottom of each screw.

4. Slide latch bar into retainer on wall bracket, handle up or down, whichever you prefer. The latch bar will go either way with the handle on the right or left side of waterer, whichever is convenient.

5. Lift drinking bowl upwards onto wall bracket such that screw heads on bowl pass through bracket and through latch bar. Slide latch bar so as to capture screw heads in slots on latch bar.

6. Place float guard over screw in center of mounting bracket and secure with acorn nut, hand tighten.

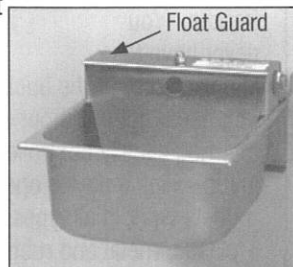

Cleaning and Sterilizing. Clean drinking bowl as required.

To remove the drinking bowl from the wall bracket, line up latch bar so that bolts on the back of the drinking bowl slide through wall bracket. Bowl may be sterilized with a disinfectant solution, but make certain the float and float arm are also immersed in the disinfectant. After disinfecting, thoroughly rinse with water.

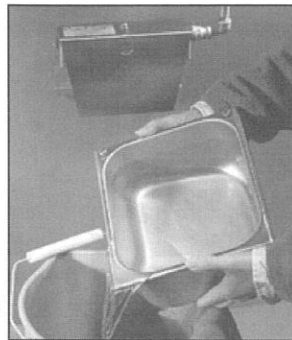

Removing Mineral Deposits. Mineral deposits can be removed from the drinking bowl by soaking the bowl in a water-vinegar solution. Remove the drinking bowl from the wall bracket. Fill the drinking bowl up with enough water to cover the mineral deposits. Mix in one cup of vinegar. Let the bowl soak for 24 hours and wipe clean.

Replacing Rubber Valve Seat. Over time, rubber seat can harden and tear. If wear on rubber valve seat causes valve to leak, resulting in overflow, replace rubber valve seat.

1. Turn off the water supply at shut-off valve.
2. Remove the Acorn nut and the Float Cover.
3. Place your index finger inside the front of the valve cap and pull gently towards the front of the waterer. While pulling out on the valve cap, use the index finger of your other hand to push the valve cap away from the valve. This will allow the Float arm assembly to release from the valve body.
4. Remove the Rubber seat from the Float arm assembly and replace with a new Rubber seat.
5. Replace the Float arm assembly into the Valve body.
6. While holding the float assembly in place, slide the Valve cap over the Valve body until you hear and feel the Valve cap snap into place.
7. Replace the Float Cover and Acorn nut.
8. Turn on the water supply.

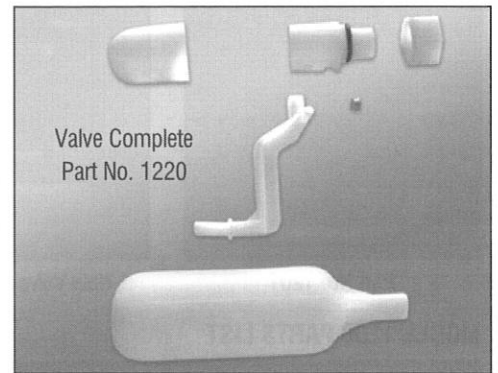

Tightening / Loosening Bowl Latch. The length the screws are backed out of drinking bowl determines how tight the bowl release latch operates. Tighten screws so that screw heads just make contact with surface of bowl then back out 2 3/4 complete rotations. The further the screws are backed out the looser the bowl release latch operates. Conversely, the further the screws are set into the drinking bowl the tighter the bowl release latch operates. Some experimentation may be required to find the optimal setting.

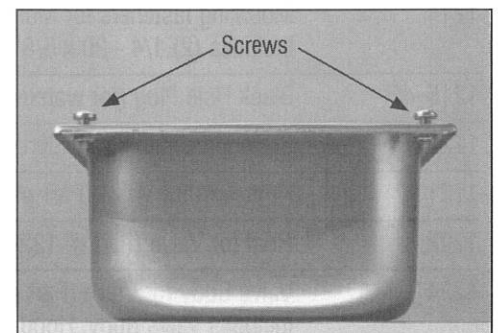

Warranty

Nelson Model 1200 Automatic Waterer is guaranteed against defects in workmanship and/or materials for One Year. Nelson Manufacturing Company will repair or, at its option, replace without charge, any parts found defective upon examination at the factory if returned within the guarantee period, transportation charges prepaid.

Replacement shipment will be made transportation charges prepaid by Nelson.

NELSON

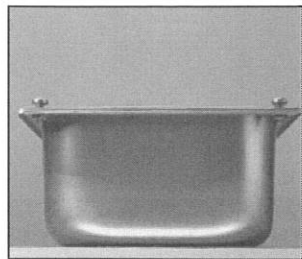

Part No. 1201

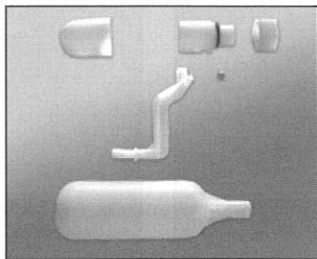

New Valve (Part No. 1220)

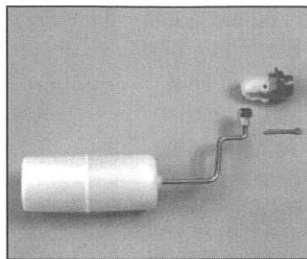

Old Valve (w/ Brass Arm)

MODEL 1200 PARTS LIST

Part Number	Description
*1201	Drinking Bowl with square corners (includes Mounting Fasteners, Part #1214)
*1201R	Drinking Bowl with two round corners and two square corners (includes Mounting Fasteners, Part #1214)
1202	Wall Bracket with Screw, Acorn Nut, and Hole Plug
1203	Latch Bar
1204	Float Cover
1220	NEW Valve Complete (white plastic) for waterers shipped after Sept. 2009
1223	Rubber Seat and O-Ring (qty. 6 ea.) for NEW Valve Complete (Part # 1220)
1209	Screw & Acorn Nut for Mounting Float Cover (Part #1204)
1214	Mounting fasteners for Mounting Drinking Bowl to Wall Bracket. Includes (2) 1/4 - 20 x 5/8" Phillips Head Screws and (2) 1/4" Hex Nut.
1215	Black Hole Plug (for waterers shipped before Dec. 31, 2010)
1225	Black Hole Plug (for waterers shipped after Jan. 1, 2011)
1221	Float Arm for Valve (Part # 1220)
1222	Float for Valve (Part # 1220)
1224	Valve Body for Valve (Part # 1220) Includes Valve Body, Hood, Nut and O-Ring
Acc. K1	Brass Shutt-off Valve 1/4 Turn
Acc. K2	Pole Mounting Kit
Acc. K3	Garden Hose Adapter
	Old Valve Complete (brass w/ plastic float). No longer available.
911	Float for OLD Valve (Part # 1207)
1206	Float Arm (brass) for OLD Valve (Part # 1207)
1208	Rubber Seat, Cotter Pin and Washer (qty 6 ea.) for OLD Valve (Part # 1207)

*The drinking bowl with the square corners was replaced with the bowl with round corners in May 2002.

To Order Parts Call **1-888-844-6606**
or go online www.nelsonmfg.com



Nelson Manufacturing Company
3049 12th St SW
Cedar Rapids, Iowa 52404
Phone: 319-363-2607
Phone: 1-888-844-6606
Fax: 319-363-3601
E-mail: support@nelsonmfg.com

Buy Direct from Nelson.

Our goal is to make it easy for you to purchase and own Nelson products. Our expertise comes from taking care of our customers for over 60 years.



Dog Feeding Pan Model 1400

Nelson Model 1400 Dog Feeding Pan is the practical, cost-effective solution for feeding dogs. The Model 1400, a companion to the model 1200 automatic waterer, is made from the same tough 304 stainless steel. Like the 1200, the bowl is attached to the wall bracket by a slide latch, making removal easy and fast for cleaning.



Automatic Horse & Livestock Waterers

Nelson Automatic Livestock and Horse Waterers provide a constant supply of fresh clean water and are available with optional heaters to prevent freeze-up, even in the coldest climates. Nelson 300 & 700 Series Automatic Waterers are available in several configurations. They're ideal for livestock, horses, exotic animals and, yes, even dogs.



Water Bucket Heaters for Dogs

With a Nelson Water Bucket Heater your dog's water never freezes. You never have to knock ice out of the bucket, and your dog never goes without water. The thermostatically controlled heater costs just pennies a day to operate. Both models work in all types of buckets – plastic, metal and rubber – up to 5 gallons, 3 year warranty.

